



FLAUTI



FLAUTI

Flauti è la nuova collezione di listelli per rivestimento in gres smaltato concepita da Ceramica Vogue con la collaborazione dello studio Marcante-Testa.

La collezione è pensata per caratterizzare lo spazio architettonico attraverso una micro struttura e la sua disposizione randomica su rete è in grado di riflettere la luce in modi sempre diversi, conferendo un continuo "movimento" alle pareti su cui posata.

Flauti include due listelli tridimensionali e un listello flat, disponibili nel formato 5x20 cm montati miscelati su rete 40x30 cm, viene presentata in 6 varianti di colori, disponibili nelle finiture lucide e opache.

Flauti risulta adatta al rivestimento di spazi interni sia residenziali che commerciali come ristoranti o negozi, per le sue caratteristiche tecniche ed espressive ne viene suggerito anche l'utilizzo in esterno come rivestimento di facciate riprendendo una tradizione tipicamente italiana che trovò la sua massima espressione nella metà del secolo scorso.

Flauti is the new stoneware listels collection for cladding, designed by Ceramica Vogue in collaboration with Marcante-Testa studio.

The collection has been conceived to feature the architectural space through a micro-structure and especially the fact that it's random meshmounted supplied makes light reflecting in different ways giving thus a sort of "movement" to the walls.

Flauti comprehends 2 tridimensional listels and a flat one, available in size 5x20 cm, mixed meshmounted on net 40x30 cm and offering 6 colour options available in both mat and glossy finish.

Flauti is suitable for the indoor cladding of residential and commercial spaces, like restaurants or stores and precisely thanks to its technical and aesthetic characteristics also for the outdoor facades, recalling a typical Italian tradition which found its highest expression in the middle of the last century.





Rivestimento/Wall:
FL LC 20 (5x20) 40x30 cm
IN Latte 5x20 cm

Giunto/Joint:
Kerakoll Fugabella Color 10
Mapei 103 Moon White





Rivestimento/Wall:
FL LM 20 (5x20) 40x30 cm

Giunto/Joint:
Kerakoll Fugabella Color 19

Pavimento/Floor:
IN Mastice 20x20 cm

Giunto/Joint:
Mapei 115 River Grey



TISSU





Rivestimento/Wall:
FL LN 20 (5x20) 40x30 cm
FS SG 20 (5x20) 40x30 cm

Giunto/Joint:
Kerakoll Fugabella Color 10
Mapei 103 Moon White





Rivestimento/Wall:
FS ST 20 (5x20) 40x30 cm

Giunto/Joint:
Mapei 139 Pink Powder

Soffitto/Ceiling:
FS ST 20 (5x20) 40x30 cm

Giunto/Joint:
Mapei 139 Pink Powder

Pavimento/Floor:
IN Ghiaccio (5x5) 40x30 cm

Giunto/Joint:
Mapei 100 White







Rivestimento/Wall:
FL LG 20 (5x20) 40x30 cm
IN Ghiaccio (5x5) 40x30 cm

Giunto/Joint:
Mapei 100 White





Rivestimento/Wall:
FS SS 20 (5x20) 40x30 cm
FL LT 20 (5x20) 40x30 cm

Giunto/Joint:
Mapei 138 Almond
Kerakoll Fugabella Color 41



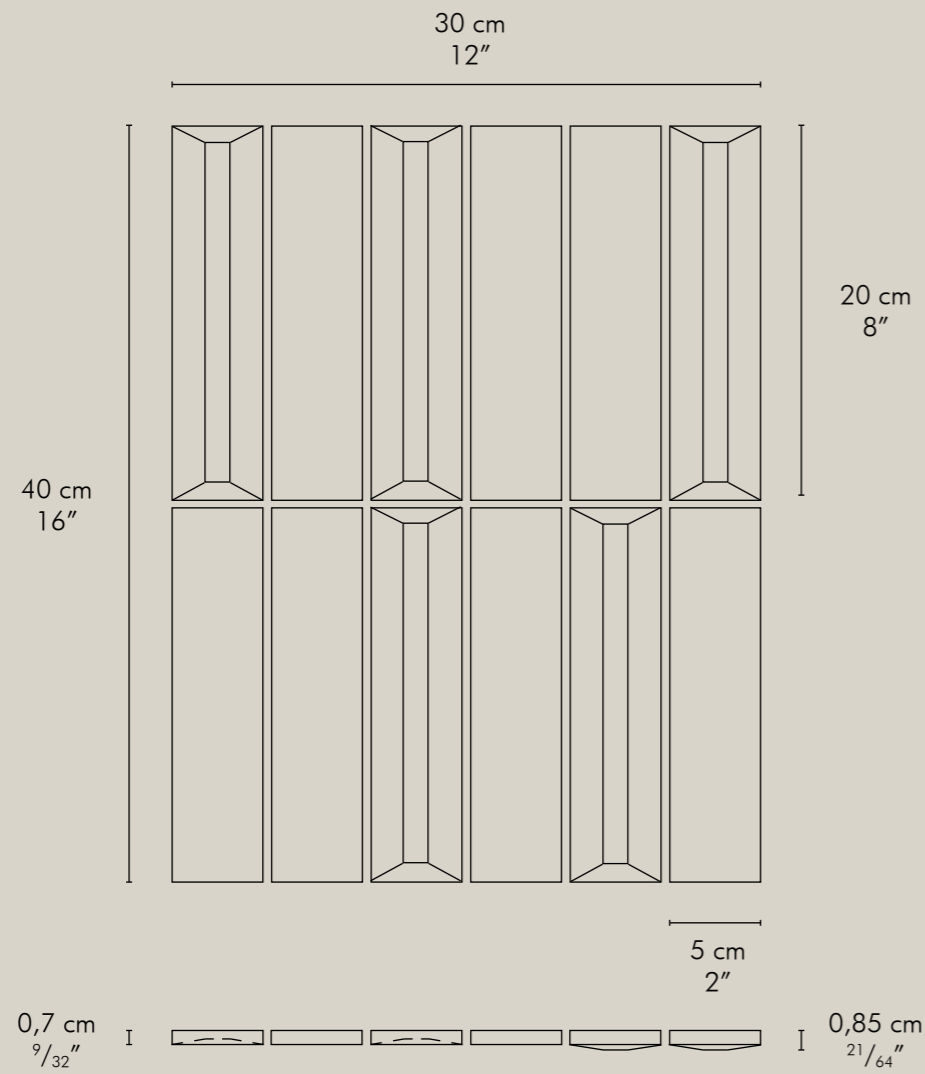

Montato su rete in fibra di vetro
Meshmounted on fibreglass net

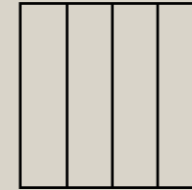

FLAUTI



FLAUTI

Finitura satinata strutturata/
structured satin finish

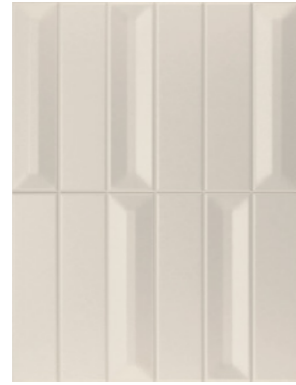

FS SG 20

GIUNTI
JOINT SUGGESTION

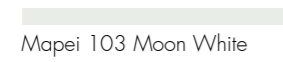

FS SS 20

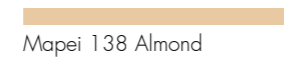

FS ST 20

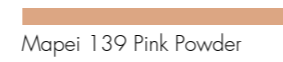

FL LG 20



FL LS 20

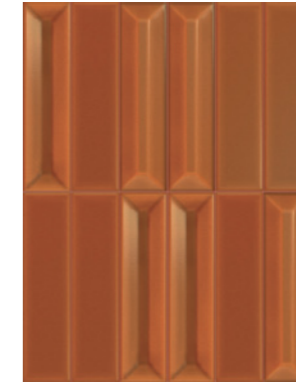
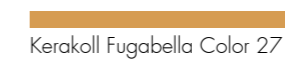

FL LT 20



FLAUTI

Finitura lucida strutturata/
structured glossy finish



FS SN 20

GIUNTI
JOINT SUGGESTION

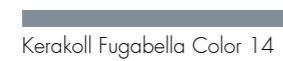

FS SM 20

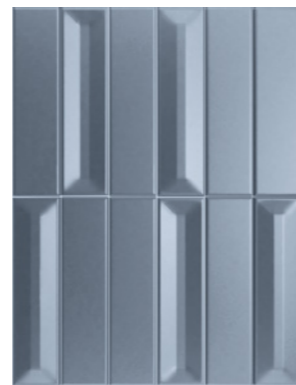

FS SC 20



FL LN 20

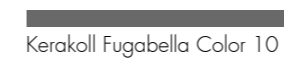

FL LM 20

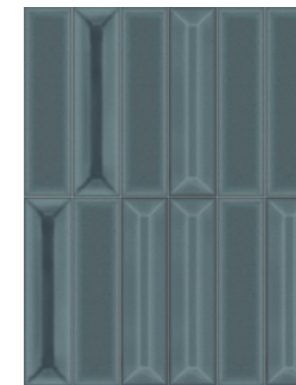
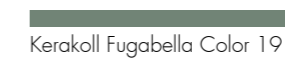

FL LC 20



GIUNTI
JOINT SUGGESTION

SCHEDE TECNICHE

TECHNICAL CHARTS

Voci di capitolato / Tender specifications

Piastrelle di ceramica pressate a secco con basso assorbimento di acqua ($0,5\% < E_b \leq 3\%$) Gruppo B1b - M - GL EN 14411:2016 appendice H.

Glazed ceramic tiles, dry pressed with low water absorption ($0,5\% < E_b \leq 3\%$) Group B1b - M - GL EN 14411:2016 H appendix.

Commenti:

La modularità e le caratteristiche dimensionali delle piastrelle Ceramica Vogue presentano valori decisamente migliorativi rispetto alle prescrizioni delle norme, che ottimizzano il risultato estetico riducendo al contempo i costi di posa. Vogue è un prodotto facile da posare. I test relativi alle proprietà chimiche confermano che i prodotti di Ceramica Vogue forniscono prestazioni elevate per quanto riguarda la facilità di manutenzione, resistenza alle macchie, igienicità. In caso di particolari esigenze relative alla resistenza chimica, sono disponibili, a richiesta, test specifici.



Remarks:

Modularity and dimensional characteristics of the Ceramica Vogue ceramic tiles are definitely over the prescriptions of the norms, enhancing the aesthetical effect and reducing at the same time the laying costs. The Vogue product is easy to lay. The tests about chemical properties confirm high performances of the Ceramica Vogue products concerning an easy maintenance, resistance to stains, hygienic conditions. In case of particular requests concerning the chemical resistance, specific tests are available on demand.





Dimensioni e qualità della superficie / Dimensions and surface quality

formato nominale nominal shape	dimensione di fabbricazione actual size	metodo di prova test methods	requisiti requirements
5x20 cm	lati sides 48,1x198,4 mm	EN ISO 10545-2	lati sides $\pm 0,6\%$
	spessore thickness 8,5 mm		spessore thickness $\pm 5\%$
Rettilinearità dei lati (superficie di esercizio) Straightness of sides (working surface)		EN ISO 10545-2	$\pm 0,5\%$
Ortogonalità Squareness		EN ISO 10545-2	$\pm 0,5\%$
Planarità della superficie Flatness		EN ISO 10545-2	$\pm 0,5\%$
Qualità della superficie Surface quality		EN ISO 10545-2	min. 95%









Altre prove / Other tests

prova test	metodo di prova test methods	requisiti requirements	risultati Vogue Vogue results
 Resistenza dei colori alla luce Colour resistance to light	DIN 51094	non previsto not foreseen	garantita guaranteed
 Reazione al fuoco Reaction to the fire	senza prova without test	decisione 96/603/CE decision 96/603/CE	classe A1

Proprietà chimiche / Chemical properties

prova test	metodo di prova test methods	requisiti requirements	risultati Vogue Vogue results
 Resistenza alle macchie Stain resistance	EN ISO 10545-14	classe 3 min.	3 min. (vedi appendice P catalogo generale) (see P appendix general catalogue)
 Resistenza ai prodotti chimici d'uso domestico ed agli additivi per piscina Resistance to chemical products for housekeeping and to the additives used in swimming-pools	EN ISO 10545-13	GB min.	GB min.
 Resistenza ad acidi e basi a bassa concentrazione Resistance to acids and bases at low concentrations	EN ISO 10545-13	indicata dal produttore indicated by the producer	GLB min.
 Resistenza ad acidi e basi ad alta concentrazione Resistance to acids and bases at high concentrations	EN ISO 10545-13	metodo di prova disponibile test method available	GHB min.
 Cessione di piombo e cadmio Lead and cadmium losses	EN ISO 10545-15	metodo di prova disponibile test method available	disponibile a richiesta available if required

Proprietà fisiche / Physical properties

prova test	metodo di prova test methods	requisiti requirements	risultati Vogue Vogue results
 Massa d'acqua assorbita (%) Water absorption (%)	EN ISO 10545-3	$0,5\% < E_b \leq 3,0\%$	$0,5\% < E_b \leq 3,0\%$
 Resistenza di rottura Tensile strength	EN ISO 10545-4	1.100 N min. spessore thickness $\geq 7,5$ mm	1.100 N min.
 Modulo di rottura Modulus of rupture	EN ISO 10545-4	30 N/mm ² min.	30 N/mm ² min.
 Coefficiente di dilatazione termica lineare Coefficient of linear thermal expansion	EN ISO 10545-8	metodo di prova disponibile test method available	$< 6,9 \times 10^{-6} / ^\circ\text{C}$
 Resistenza agli sbalzi termici Thermal shock resistance	EN ISO 10545-9	metodo di prova disponibile test method available	garantita guaranteed
 Resistenza al cavillo Crazing resistance	EN ISO 10545-11	richiesta required	garantita guaranteed
 Resistenza al gelo Frost resistance	EN ISO 10545-12	metodo di prova disponibile test method available	garantita guaranteed
 Dilatazione dovuta all'umidità Expansion to humidity	EN ISO 10545-10	metodo di prova disponibile test method available	$< 0,04\%$
 Resistenza all'urto Impact resistance	EN ISO 10545-5	metodo di prova disponibile test method available	$> 0,6$ (vedi appendice P catalogo generale) (see P appendix general catalogue)

SCHEDE TECNICHE

TECHNICAL CHARTS

Manutenzione e pulizia

La qualità di un rivestimento in piastrelle ceramiche dipende, oltre che da una buona progettazione e da una corretta posa, anche dalla cura che verrà rivolta alle superfici.

Le piastrelle Ceramica Vogue in grès smaltato in pasta bianca ingelivo sono resistenti, igieniche e facili da pulire, non richiedono particolari cure ma solo l'applicazione di alcune elementari norme di pulizia.

È importante distinguere tra pulizia di fine cantiere e pulizia ordinaria.

Pulizia di fine cantiere

Oltre a mantenere sempre protette le superfici durante la fasi di cantiere, è di fondamentale importanza curare la prima pulizia. Questa operazione ha lo scopo di eliminare ogni traccia e residuo di posa dalla superficie delle piastrelle. Prima del lavaggio è importante rimuovere con un aspiratore lo sporco grossolano evitando di rigare la superficie delle piastrelle. La pulizia deve essere fatta con prodotti in commercio tipo Deterdek Pro (www.filachim.com), Keranet (www.mapei.com) o prodotti similari. Si raccomanda di seguire rigorosamente le indicazioni riportate sulle schede tecniche dei prodotti utilizzati e comunque di fare delle prove dei prodotti di pulizia su una piccola porzione di una piastrella prima di eseguire la pulizia totale della superficie.

Pulizia ordinaria

Per la pulizia ordinaria è bene usare prodotti in grado di eliminare eventuali macchie di sporco senza però intaccare la smaltatura superficiale, evitare quindi sostanze molto aggressive quali prodotti a base acida.

Usare semplici prodotti adatti alla pulizia della ceramica. Per migliorare l'efficacia dei detergenti diluirli con acqua calda.

Norme generali

Sostanze abrasive o strumenti per la pulizia quali spugne abrasive o spazzole eccessivamente dure sono sconsigliati in quanto potrebbero provocare sulla superficie delle piastrelle graffi o segni impossibili poi da eliminare.

Sui prodotti con caratteristiche antiscivolo evitare assolutamente l'utilizzo di prodotti lavaincera o cere.

Nel caso di locali comunicanti con l'esterno è indispensabile utilizzare zerbini per ridurre l'apporto di agenti abrasivi.

Maintenance

The quality of a ceramic wall tile depends not only on proper design and laying, but also the care taken of the surface thereafter. Ceramica Vogue frost resistant white body glazed stoneware tiles are hard-wearing, hygienic and easy to clean. They require no particular maintenance other than the application of a number of simple cleaning rules.

It is important to distinguish between the cleaning to be carried out when the building work is complete and ordinary cleaning.

Cleaning after building work is completed

In addition to keeping surfaces protected during the various phases of the building work, it is of fundamental importance to ensure the tiles are cleaned properly for the first time once the building work is complete.

The purpose of this operation is to remove all traces and residue from the laying process from the surface of the tiles. Before washing the tiles, it is important to vacuum off the worst of the dirt, without scratching the surface of the tiles. Cleaning must be done using products such as Deterdek Pro (www.filachim.com), Keranet (www.mapei.com) or similar.

The indications on the technical specifications of the products used must be followed very carefully, and all cleaning products should be tested on a small portion of a tile before proceeding to clean the whole surface.

Ordinary cleaning

For ordinary cleaning, it is best to use products able to remove any dirty marks without damaging the surface glaze, avoiding particularly aggressive (e.g. acid-based) products.

Use simple products suitable for cleaning ceramics. To improve the efficacy of the cleaning agents, dilute them in hot water.

General rules

Abrasive substances or cleaning instruments such as abrasive sponges or excessively hard brushes should be avoided, because they could scratch the surface or leave marks that will be impossible to remove. On products with anti-slip characteristics, wash and wax or wax products must not be used. For areas that lead directly outdoors, mats must be used in order to limit the abrasive agents brought in.

Conformità alla Normativa

Il materiale Ceramica Vogue (prima scelta) è conforme a quanto previsto dalla normativa UNI EN 14411-2012 - Appendice H.

Il sistema di gestione applica quanto previsto dalle Norme della Serie ISO 9000, ISO 14000 e dal Regolamento CE761/2001 EMAS.

L'intero ciclo produttivo è dotato di Autorizzazione Integrata Ambientale, ai sensi dell'art. 4 D.Lgs 372/99 (I.P.P.C)

Conformity to Standards

Ceramica Vogue material (best quality) complies with the provisions of standard UNI EN 14411-2012 – Appendix H.

The management system applies the provisions of the Standards in the series ISO 9000, ISO 14000 and the CE761/2001 EMAS Regulation.

The whole production cycle is covered by an Integrated Environmental Authorisation, pursuant to Art. 4 of Italian Legislative Decree

(D.Lgs) 372/99 (I.P.P.C)

Marcatura CE

Il Regolamento Europeo 305/2011 (CPR) abroga la Direttiva 89/106/CEE sui prodotti da costruzione (CPD) introducendo dal 01/07/2013 alcune importanti novità nell'ambito della Marcatura CE dei prodotti da costruzione.

La Dichiarazione di Conformità dei prodotti da costruzione viene sostituita dalla Dichiarazione di Prestazione (DoP) con diverso significato e contenuto. In assenza di questa dichiarazione i prodotti non possono circolare all'interno dei confini dell'Unione Europea. La presenza del marchio CE su tutti gli imballi di Ceramica Vogue attesta che, il prodotto in essi contenuto è conforme a quanto dichiarato nelle schede tecniche, e la costanza delle prestazioni del prodotto è stata verificata ed attestata a garanzia dell'utilizzatore.

CE mark

European Regulation 305/2011 (CPR) abrogates Directive 89/106/EEC concerning construction products, introducing a number of important changes concerning the CE mark on construction products effective 01/07/2013.

The Declaration of Conformity for construction products is replaced by the Declaration of Performance (DoP), with a different meaning and different content. Products cannot circulate within the European Union without this declaration.

The presence of the CE mark on all Ceramica Vogue packages demonstrates that the product contained in them conforms to the declarations of the technical information sheets and that the constancy of the product's performance has been tested as a guarantee for the user.

Determinazione della pulibilità e analisi microbatterica

I materiali di Ceramica Vogue, previa accurata pulizia con prodotti specifici, non favoriscono il proliferare dei batteri (prova di laboratorio disponibile).

Determination of cleanability and microbacterial analysis

Ceramica Vogue materials, if properly cleaned with appropriate cleaning products, do not promote the proliferation of bacteria (laboratory tests available).



www.ceramicavogue.it

made in italy

ART DIRECTION: Marcante - Testa

Progetto ambienti interni: Marcante - Testa

Produzione immagini e styling: Iride

Stampa: INGRAPH Printing Solutions

Ufficio stampa: info@sabrinagiacchetti.it

Stampato in Italia Ottobre 2020

Ceramica VOGUE
è un marchio di

altareco
GRUPPO INDUSTRIALE



Socio Ordinario
del GBC Italia



Ceramics of Italy



Ceramica VOGUE
Via Papa Giovanni XIII, 100 - Loc. Vergnasco
13882 Cerrione (BI) ITALIA
T. +39.015.672.1
Fax +39.015.671.626 (Italia)
Fax +39.015.671.352 (Export)
info@cervogue.com

I colori di stampa sono puramente indicativi
The colours appearing in the illustrations are merely indicative

Ceramica
VOGUE

TILES FOR ARCHITECTURE

www.ceramicavogue.it

made in italy